



FastClamp[®]



Fittings & Technical Guide



The safe clamping system for circular hollow section tube

Access Technologies Limited was established in 1995 to manufacture access equipment for the Construction Industry. The **FastClamp** brand followed as a natural progression four years later and has since grown to become one of the premier ranges of slip on tubular fittings available today.

FastClamp is a range of fittings manufactured from Malleable Iron to BS EN 1562 or Ductile Iron (where noted in the fittings description) to BS EN 1563. **FastClamp** fittings are used to construct lightweight tubular steel structures and are manufactured to suit five different tube sizes.

FastClamp fittings require no welding, drilling or special tools, simply use a hexagon key to tighten the special setscrews that embed into the tube. **FastClamp** fittings will support an axial load of up to 900 kg when tightened to a torque of 39Nm.

FINISHES AVAILABLE

FastClamp castings are Hot dip Galvanised to BS EN ISO 1461 as standard. **FastClamp** fittings can also be supplied in a powder coated finish to RAL standard colours, subject to quantity and availability from the coaters.

FASTCLAMP SELECTION

FastClamp fittings are suitable for use with steel tubes to BS EN 10255 with a minimum wall thickness of 3.2mm, however please note that internal fitting types: C01, C06, C65, DDA-02 & DDA-06 are only designed for use with 3.2mm thick tube.

Product codes are constructed as follows:

- C** = FastClamp
- No.** = FastClamp type
- G** = Galvanised
- P** = Plastic
- S** = Stainless Steel
- No.** = Tube size

Example: **C00G20** is a FastClamp, type 00, galvanised and suitable for 26.9mm diameter tube.

Fitting	Tube size \varnothing	Nominal bore of tube	
		Metric	Imperial
20	26.9mm	20	3/4"
25	33.7mm	25	1"
32	42.4mm	32	1 1/4"
40	48.3mm	40	1 1/2"
50	60.3mm	50	2"

Important Note: The Tube Size \varnothing should be the first consideration as this is the primary structural component for any FastClamp structure. The application guidelines on the next page will help the design of Racking, General Structures and Handrail.

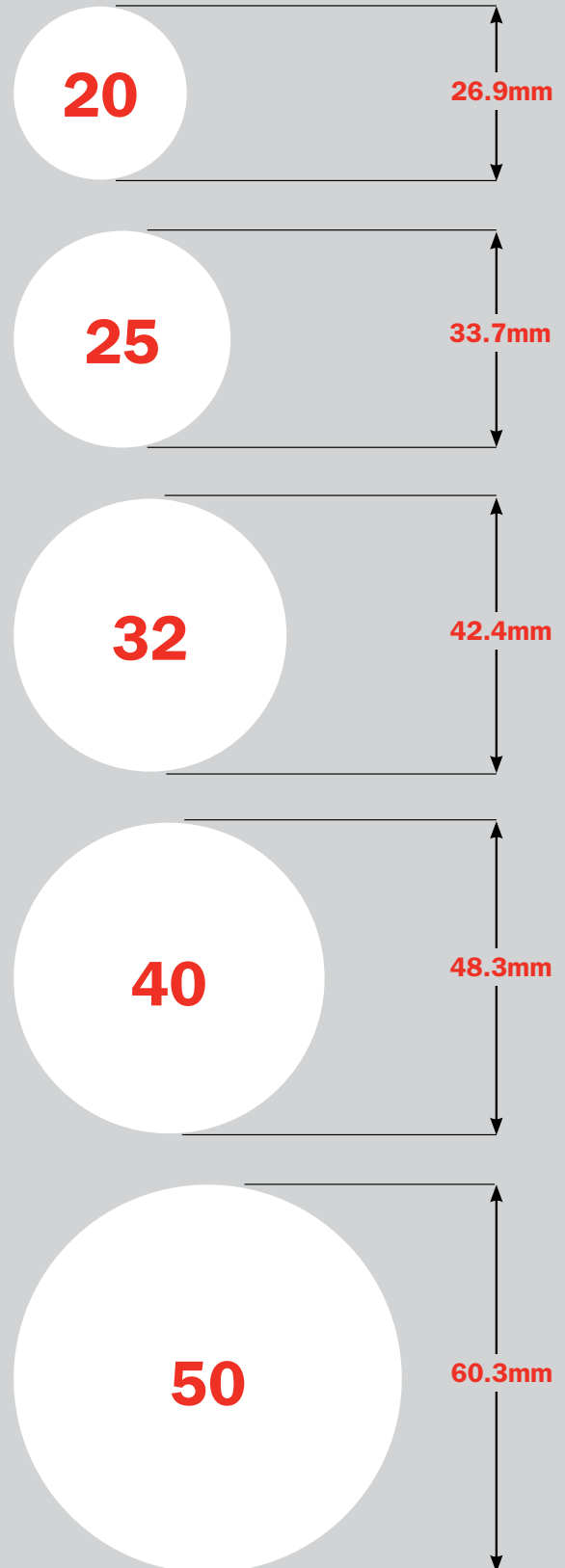

Racking and general structures

Racking and general structures can be constructed using **FastClamp** fittings. Care must be taken to ensure that the tube size selected is adequate for the loads anticipated. To help with the selection of the correct tube, table 1 provides the uniformly distributed loads that can be supported between upright posts, assuming that the load is supported by two tubes. These loads are calculated based on the maximum bending moment for the tube.

Table 2 provides the load capacity for single upright posts with various unsupported lengths. These loads are based on the compression strength and buckling loads of the circular hollow section (CHS) tube.

NB. When designing structures care must be taken to ensure that the load on any one grub screw does not exceed 900kg.

For further help in using **FastClamp** please contact our sales office.

Horizontal tubes load capacity

Uniformly distributed load in kg using two horizontal tubes

Span (m)	Tube Ø				
	26.9mm x 2.6	33.7mm x 3.2	42.4mm x 3.2	48.3mm x 3.2	60.3mm x 3.6
0.5	540	1060	1750	2380	4000
0.6	435	850	1407	1870	3250
0.7	375	730	1207	1595	2760
0.8	330	645	1063	1385	2420
0.9	295	579	946	1230	2160
1.0	265	525	850	1110	1950
1.1	240	478	770	1013	1775
1.2	219	438	705	930	1625
1.3	202	403	651	858	1497
1.4	187	373	604	796	1387
1.5	175	347	564	741	1290
1.6	-	325	529	693	1205
1.7	-	306	499	650	1129
1.8	-	290	472	613	1061
1.9	-	277	448	581	999
2.0	-	268	427	553	987
2.1	-	-	408	528	944
2.2	-	-	391	505	855
2.3	-	-	376	485	818
2.4	-	-	362	467	785
2.5	-	-	349	450	755
2.6	-	-	-	434	728
2.7	-	-	-	419	703
2.8	-	-	-	405	680
2.9	-	-	-	-	659
3.0	-	-	-	-	639
3.1	-	-	-	-	620
3.2	-	-	-	-	603
3.3	-	-	-	-	588
3.4	-	-	-	-	575
3.5	-	-	-	-	564

Grade: BS EN 10255 (ISO 65)

Vertical strut load capacity

Vertical load in kg per strut

Length (m)	Tube Ø				
	26.9mm x 2.6	33.7mm x 3.2	42.4mm x 3.2	48.3mm x 3.2	60.3mm x 3.6
0.3	1720	2950	4038	4783	7044
0.4	1435	2617	3703	4446	6661
0.5	1150	2284	3368	4109	6278
0.6	910	1951	3033	3772	5895
0.7	725	1618	2690	3435	5512
0.8	590	1348	2363	3098	5129
0.9	480	1128	2028	2761	4746
1.0	-	948	1752	2424	4363
1.1	-	798	1524	2134	3980
1.2	-	-	1340	1884	3597
1.3	-	-	1188	1668	3253
1.4	-	-	1066	1484	2951
1.5	-	-	-	1328	2681
1.6	-	-	-	-	2441
1.7	-	-	-	-	2226
1.8	-	-	-	-	2032
1.9	-	-	-	-	1857
2.0	-	-	-	-	1697

Grade: BS EN 10255 (ISO 65)

Guardrail

Guardrail is the most common form of structure that is built with **FastClamp** fittings and requires careful consideration to meet required design loadings. Design loads are usually specified, however if unsure BS 6399 and BS 6180 are good reference documents.

The loading capacity of any guardrail structure is determined principally by the diameter, thickness and frequency of its Uprights. The table below contains our recommendations to safely meet the stated design loads based on the maximum permissible bending moment of the Upright tube.

Design Load	Tube Ø					
	33.7 x 3.2mm	42.4 x 3.2mm	42.4 x 4.0mm	48.3 x 3.2mm	48.3 x 4.0mm	48.3 x 5.0mm
Maximum Upright Centres (mm)						
900 mm high						
360 N/m	814	1369	1595	1828	2584	3052
740 N/m	396	666	776	889	1257	2229
1500 N/m	195	329	383	439	620	1100
1000 mm high						
360 N/m	732	1232	1435	1645	2326	2930
740 N/m	356	599	698	800	1131	2006
1500 N/m	176	296	345	395	558	990
1100 mm high						
360 N/m	666	1120	1305	1496	2114	2778
740 N/m	324	545	635	728	1028	1824
1500 N/m	160	269	313	359	507	900

Grade: BS EN 10255 (ISO 65)
 Rails need only be 3.2mm thick and the same diameter as the Upright.

Applications

FastClamp® is the safe and simple solution to build many different types of lightweight tubular structures, the applications are only limited by imagination and the following is just a small selection of what can be constructed.

- Handrailing
- Guardrailing
- Tyre racks
- Car ports
- Polytunnels
- Fruit cages
- Shopfitting
- Greenhouses
- Barriers
- Disabled ramps
- Sheds
- Roof Edge Protection
- Frames
- Canopies
- Market stalls
- Storage racks
- Work benches
- Exhibition stands
- Cattle pens
- Cricket screens
- Security screens
- Stables
- Climbing frames
- Goalposts



Trolley Parks



Roof Edge Protection



Fruit Cages



Stables

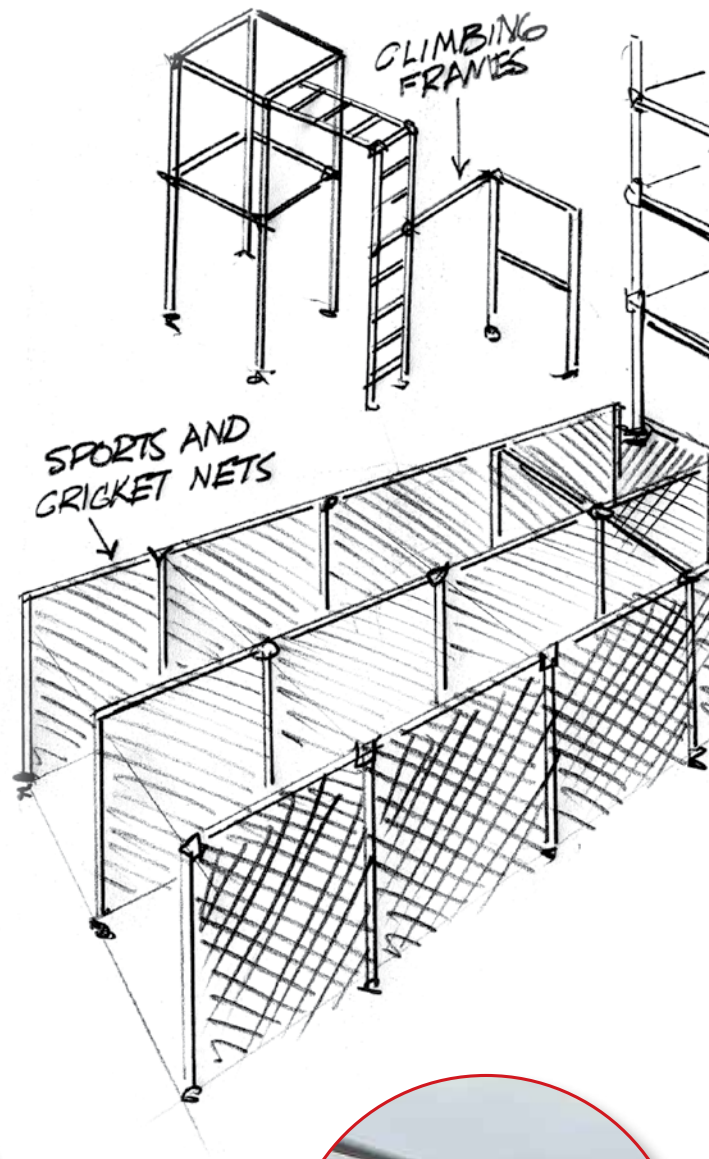

Guardrailing



Cricket Screens



Domestic Projects

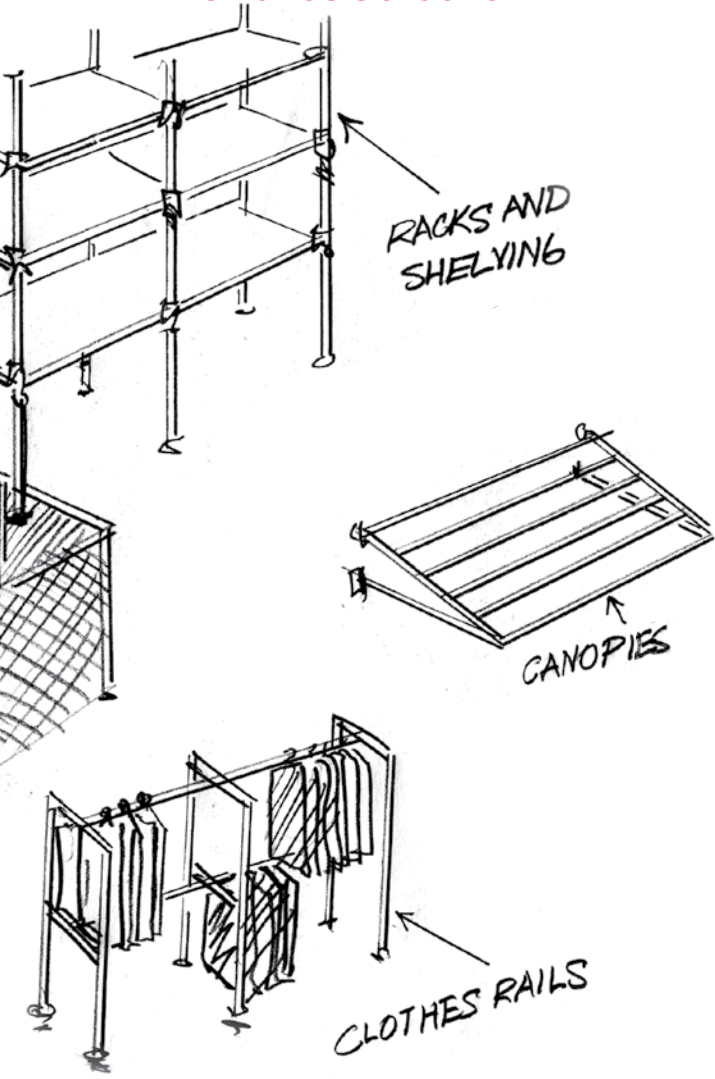

Railing



Storage Racks



Handrails

BC05 Swivel Elbow

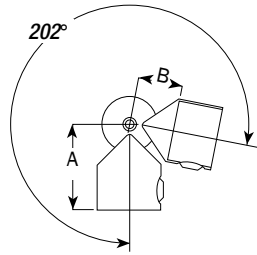

Type	Tube Size	A	B	Kg
BC05G40	48.3	83	45	1.14

Type BC05 fitting has been designed as a variable angle in-line connection, adjustable through 202°.

WARNING! An entire structure should not be constructed from Type BC05 or any other swivel fitting, as these would not provide sufficient stability or rigidity in the structure due to the free rotation of the fitting.

CA03 Add On Short Tee

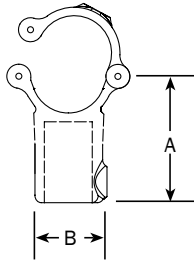

Type	Tube Size	A	B	Kg
CA03G32	42.4	60	55	0.60
CA03G40	48.3	68	60	0.71

The Add On short Tee allows existing structures to be added to without the need for any dismantling. Tubes must not be jointed within this fitting.

CA40 Add On 90° Crossover

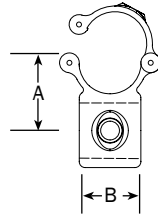

Type	Tube Size	A	B	Kg
CA40G32	42.4	49	46	0.65
CA40G40	48.3	55	50	0.73

The Add On 90° Crossover allows existing structures to be added to without the need for any dismantling. This fitting is designed to give a 90° offset crossover joint. Tubes must not be jointed within this fitting.

C00 Sleeve Joint

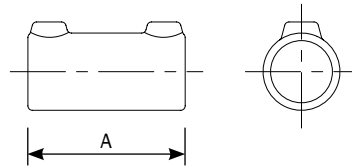

Type	Tube Size	A	Kg
C00G20	26.9	76	0.33
C00G25	33.7	89	0.39
C00G32	42.4	102	0.50
C00G40	48.3	100	0.55
C00G50	60.3	120	1.14

The Sleeve Joint is designed to provide an in-line joint between two tubes of the same diameter.

C01 Expanding Connector

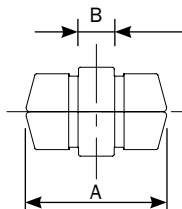

Type	Tube Size	A	B	Kg
C01G25	33.7	75	19	0.18
C01G32	42.4	75	19	0.27
C01G40	48.3	75	19	0.35

The expanding Connector is designed to provide an in line joint between tubes of the same diameter, and a wall thickness of 3.2mm. It fits flush with the tube surface and can be located inside other fittings. It must not be used as a load-bearing joint, for such applications use a **FastClamp** type C00.

WARNING! In-line internal connector for joining two tubes together. Only medium gauge 3.2mm wall thick tube can be used. The 150 should never be used as a load bearing joint. The 150 must be used within 100mm of an upright.

C02 90° Elbow

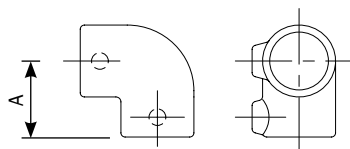

Type	Tube Size	A	Kg
C02G20	26.9	40	0.24
C02G25	33.7	48	0.39
C02G32	42.4	60	0.53
C02G40	48.3	67	0.68
C02G50	60.3	86	1.53

The 90° Elbow is designed to provide a joint between two tubes at right angles to each other. Often used for railing ends and corners.

C03 Short Tee

Type	Tube Size	A	B	Kg
C03G20	26.9	40	38	0.21
C03G25	33.7	48	45	0.35
C03G32	42.4	60	54	0.44
C03G40	48.3	67	60	0.56
C03G50	60.3	86	71	0.76

The Short Tee is designed to provide a butt joint between two tubes at right angles to each other. Often used for railing ends and tops. If tubes need to be joined inside the fitting then a C04G type should be used.

C04 Long Tee

Type	Tube Size	A	B	Kg
C04G20	26.9	40	80	0.35
C04G25	33.7	48	96	0.52
C04G32	42.4	60	122	0.77
C04G40	48.3	67	134	0.88
C04G50	60.3	86	172	1.33

The Long Tee is designed to provide a butt joint between two tubes at right angles to each other. Often used for railing ends and tops. It allows the through tube to be joined inside the fitting. An alternative is the C03G type fitting.

C05 Variable Elbow (15° to 60°)

Type	Tube Size	A	B	C	D	Kg
C05G25	33.7	65	60	13	50	0.43
C05G32	42.4	80	66	16	55	0.66
C05G40	48.3	95	75	17	55	0.91

The Variable Elbow is designed to make joints at an angle of between 15° and 60°.

C05A Variable Elbow (11° to 30°)

Type	Tube Size	A	B	C	D	Kg
C05AG32	42.4	84	84	16	92	0.82
C05AG40	48.3	94	94	16	102	1.01

The variable elbow is designed to make joints at an angle of between 11° & 30°.

C06 Internal T Joint

Type	Tube Size	A	B	C	Kg
C06G25	33.7	23	33	34	0.33
C06G32	42.4	29	42	40	0.54
C06G40	48.3	31	48	44	0.68

The Internal T joint is designed to provide an angled joint between a tube and a **FastClamp** fitting when used in conjunction with C02G and C03G type fittings. Often used for railing tops and midrails to accommodate a slope as offset railing.

C07 45° Tee

Type	Tube Size	A	Kg
C07G25	33.7	45	0.38
C07G32	42.4	54	0.63
C07G40	48.3	60	0.83

The 45° Tee is used as a bracing and strut component for strengthening structures.

C10G Swivel Base

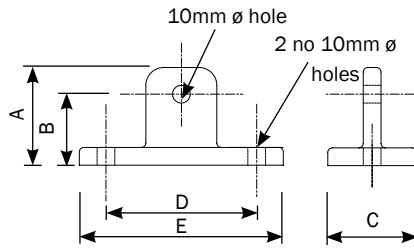

Type	Tube Size	A	B	C	D	E	Kg
C10G	N/A	50	40	50	81	111	0.51

The Swivel Base is designed to provide a base fixing. It is usually used in conjunction with a C36G type fitting to make a C46G type base swivel combination. This fitting does not provide sufficient rigidity to be used as a railing base without other means of support.

C11 Wall Flange

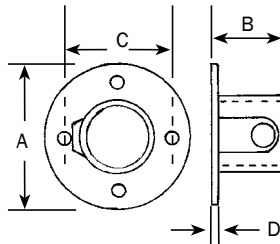

Type	Tube Size	A	B	C	D	Ø	Kg
C11G20	26.9	86	42	57	4	9	0.35
C11G25	33.7	89	45	64	6	9	0.39
C11G32	42.4	102	50	76	6	9	0.50
C11G40	48.3	114	57	89	6	9	0.65
C11G50	60.3	127	64	95	6	9	1.10

The Wall Flange is designed to provide a positional wall or base fixing. It is not recommended to use this fitting as a structural railing base.

C12 Railing Base Flange

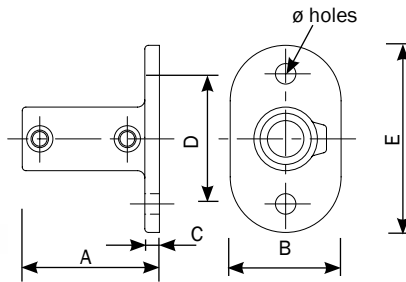

Type	Tube Size	A	B	C	D	E	Ø	Kg
C12G20	26.9	76	65	8	76	114	11	0.60
C12G25	33.7	89	76	9	89	128	14	0.91
C12G32	42.4	89	80	10	102	140	14	1.03
C12G40	48.3	89	89	10	114	152	14	1.24
C12G50	60.3	128	88	9	127	165	18	1.89

The Railing Base is designed to provide a base for railings and other structures. It is recommended that this fitting be used in accordance with **FastClamp** maximum post centre dimensions, see table 3 on our Technical Page.

C13 Railing Vertical Side Support

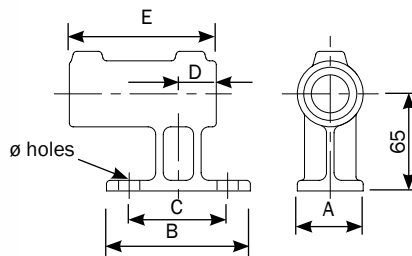

Type	Tube Size	A	B	C	D	E	Ø	Kg
C13G25	33.7	45	96	67	28	104	14	0.95
C13G32	42.4	50	109	78	30	114	14	1.20
C13G40	48.3	60	123	86	34	120	14	1.50

The Railing Vertical Side Support is designed to provide a base for railings and other structures that need a side mounted fixing. It is recommended that this fitting be used in accordance with **FastClamp** maximum post centre dimensions, see table 3 on our Technical Page.

C14 Railing Horizontal Side Support

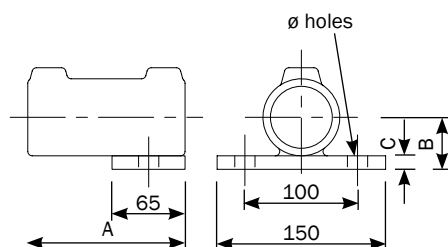

Type	Tube Size	A	B	C	Ø	Kg
C14G25	33.7	90	30	12	18	1.08
C14G32	42.4	90	35	12	18	1.32
C14G40	48.3	90	41	15	18	1.67

The Railing Horizontal Side Support is designed to provide a base for railings and other structures that need a side mounted fixing. It is recommended that this fitting be used in accordance with **FastClamp** maximum post centre dimensions, see table 3 on our Technical Page.

C15 Side Palm Fixing

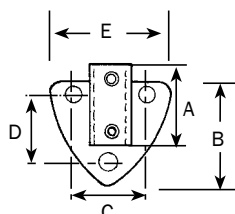

Type	Tube Size	A	B	C	D	E	Ø	Kg
C15G25	33.7	76	89	71	63	97	11	0.63
C15G32	42.4	84	98	82	72	108	11	0.80
C15G40	48.3	92	104	86	78	112	11	0.84

The Side Support is designed to provide a base for railings and other structures that need a side mounted fixing. It is recommended that this fitting be used in accordance with **FastClamp** maximum post centre dimensions, see table 3 on our Technical Page.

C16 Handrail Bracket

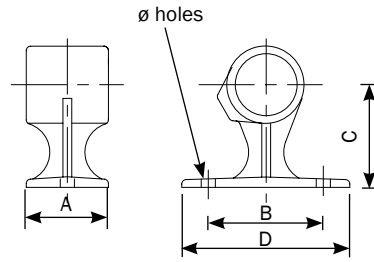

Type	Tube Size	A	B	C	D	Ø	Kg
C16G20	26.9	44	57	55	78	9	0.33
C16G25	33.7	44	63	57	82	11	0.40
C16G32	42.4	44	76	63	102	11	0.54
C16G40	48.3	48	85	67	108	11	0.63

The Handrail Bracket is designed to secure handrail tube to a wall. It can also be used on top of walls as a fixing for a low rail.

C17 Ground Support

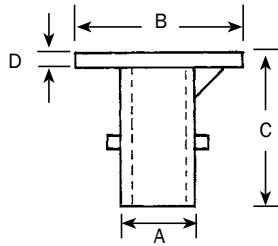

Type	Tube Size	A	B	C	D	Kg
C17G25	33.7	60	140	130	4.5	1.42
C17G32	42.4	60	140	130	4.5	1.42
C17G40	48.3	60	140	130	4.5	1.42

The Ground Socket is designed to provide a base that can be cast into the ground to support a post. The post is removable. It is recommended that this fitting be used in accordance with **FastClamp** maximum post centre dimensions, see table 3 on our Technical Page.

C18 Base Flange with Integrated Toeboard

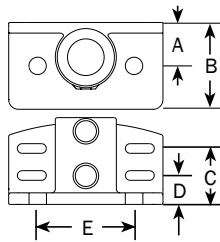

Type	Tube Size	A	B	C	D	E	Ø	Kg
C18G32	42.4	45	90	58	30	100	18	2.14
C18G40	48.3	45	90	58	30	100	18	2.28

The Base Flange with Integrated Toeboard is ideal for guardrailing and balustrading applications where the addition of a toeboard is required. The side plates have slotted holes to allow for a degree of sideways movement for ease of installation. It is recommended that this fitting be used in accordance with **FastClamp** maximum post centre dimensions, see table 3 on our Technical Page.

C20 3 Way 90° Elbow

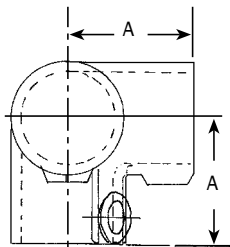

Type	Tube Size	A	Kg
C20G20	26.9	40	0.37
C20G25	33.7	48	0.51
C20G32	42.4	60	0.80
C20G40	48.3	67	0.97
C20G50	60.3	84	1.82

The 3 way 90° Elbow is designed to provide a neat corner for the upper rail of guardrail or frames.

C21 Corner c/w Through Tube

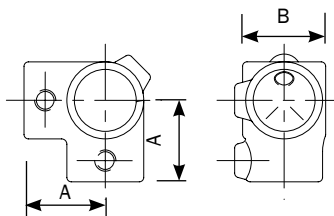

Type	Tube Size	A	B	Kg
C21G20	26.9	40	38	0.21
C21G25	33.7	48	45	0.39
C21G32	42.4	60	54	0.58
C21G40	48.3	67	60	0.69
C21G50	60.3	86	71	1.10

The Corner Complete with through tube is designed to provide a 90° corner for the intermediate rail of guardrail or frames.

C22 Two Socket Cross

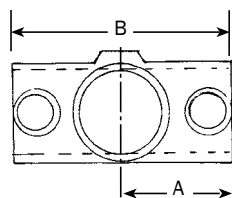

Type	Tube Size	A	B	Kg
C22G20	26.9	40	80	0.28
C22G25	33.7	48	95	0.39
C22G32	42.4	60	120	0.57
C22G40	48.3	67	134	0.65
C22G50	60.3	86	172	1.26

The Two Socket Cross fitting provides the midrail joint for handrail and other structures. It is recommended that the handrail post is continuous through the fitting.

C23 45° Side Outlet Tee

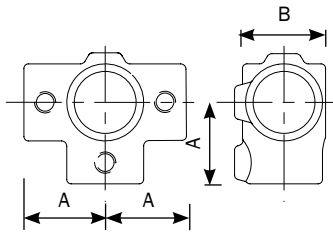

Type	Tube Size	A	B	Kg
C23G20	26.9	40	38	0.32
C23G25	33.7	48	45	0.55
C23G32	42.4	60	54	0.83
C23G40	48.3	66	60	0.84
C23G50	60.3	86	71	1.48

The Side Outlet Tee fitting provides a three way midrail joint for handrail and other structures. It is recommended that the handrail post is continuous through the fitting.

C24 4 Way Cross + Central Tube

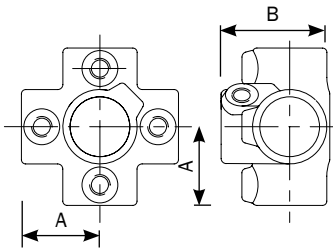

Type	Tube Size	A	B	Kg
C24G20	26.9	41	59	0.43
C24G25	33.7	48	65	0.75
C24G32	42.4	60	80	1.14
C24G40	48.3	67	85	1.19
C24G50	60.3	86	90	2.12

The 4 Way Cross fitting provides a four way midrail joint for handrail and other structures. It is recommended that the handrail post is continuous through the fitting. This fitting may also be used for the top rail with the centre post capped with a C65 Plastic Stop End.

C25 Short Tee Swivel (Normally used in pairs)

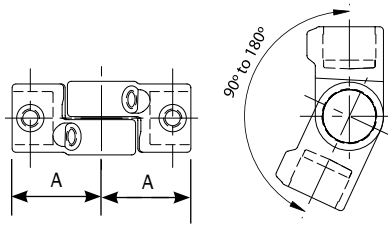

Type	Tube Size	A	Kg
C25G20	26.9	65	0.31
C25G25	33.7	66	0.37
C25G32	42.4	73	0.48
C25G40	48.3	81	0.49
C25G50	60.3	110	0.85

Short Tee Swivel fittings are normally used in pairs to facilitate corner angles of 90° to 180°. It is also used on staircases with a C02 and C03 fittings in conjunction with a short piece of tube and a C65 Plastic End Cap in landing areas. When ordering please specify the number of fittings required, not the number of pairs.

C28 Adjustable 2 Socket Cross (30° to 60°)

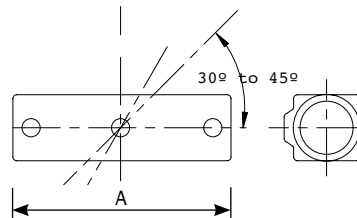

Type	Tube Size	A	Kg
C28G25	33.7	162	0.71
C28G32	42.4	190	1.12
C28G40	48.3	218	1.38

The Adjustable 2 Socket Cross fitting will accommodate any rake angle from 30° to 45°. This fitting is not recommended as the top fitting on a guardrail or balustrade system, use the C29 Adjustable Short Tee.

C29 Adjustable 2 Socket Cross (30° to 60°)

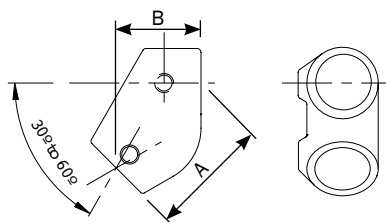

Type	Tube Size	A	B	Kg
C29G25	33.7	74	54	0.47
C29G32	42.4	85	63	0.63
C29G40	48.3	102	68	0.78

The Adjustable Short Tee fitting will accommodate any rake angle from 30° to 60°. This fitting is commonly used for the top rail of handrail to accommodate the rake angle on slopes. It can also be used for any Tee Joint to make at an angle of between 30° and 60° for light weight structures.

C30 Collar

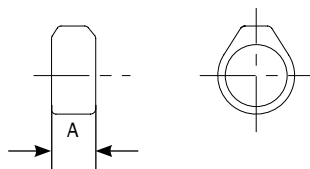

Type	Tube Size	A	Kg
C30G20	26.9	22	0.08
C30G25	33.7	25	0.13
C30G32	42.4	25	0.16
C30G40	48.3	25	0.18
C30G50	60.3	40	0.32

The Collar fitting can be used to support the C03 fitting when the latter is used as a hinge. It can also be used to increase the load capacity of another fitting when used together. The C30 can be used as a stop for a sliding tube.

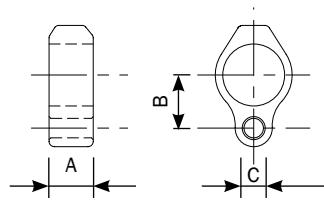
C31 Gate Eye

Type	Tube Size	A	B	C	Kg
C31G20	26.9	25	30	15	0.14
C31G25	33.7	25	33	15	0.19
C31G32	42.4	25	38	15	0.25
C31G40	48.3	25	41	15	0.26

This fitting is designed as a gate eye for light weight gates. If a heavy gate is being used we recommend that C03 and C30 type fittings are used to support the gate.

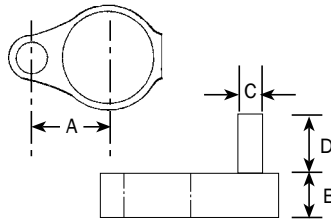
C32 Gate Hinge

Type	Tube Size	A	B	C	D	Kg
C32G20	26.9	30	25	13	38	0.21
C32G25	33.7	33	25	13	38	0.27
C32G32	42.4	38	25	13	38	0.30
C32G40	48.3	41	25	13	38	0.32

This fitting is designed as a gate hinge for light weight gates. If a heavy gate is being used we recommend that C03 and C30 type fittings are used to support the gate.

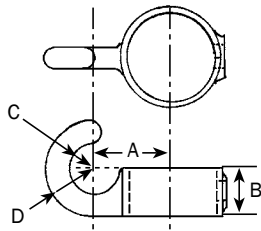
C33 Hook

Type	Tube Size	A	B	C	D	Kg
C33G20	26.9	32	25	10	25	0.17
C33G25	33.7	34	25	13	21	0.24
C33G32	42.4	39	25	13	25	0.25
C33G40	48.3	41	25	13	25	0.30

The fitting is designed to provide an attachment for chain.

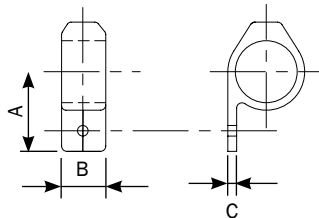
C34 Fixing Pad

Type	Tube Size	A	B	C	Ø	Kg
C34G25	33.7	45	25	5	6	0.16
C34G32	42.4	53	40	5	11	0.32
C34G40	48.3	56	40	5	11	0.35

The fitting is designed to provide an attachment for flat sheets or board. It may also be used as a gate stop. An alternative fitting for the attachment of boards is the C35 type.

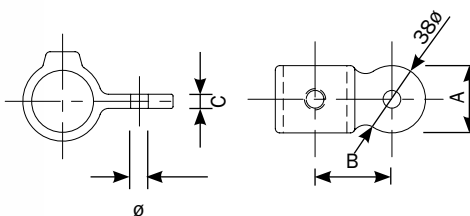
C35 Male Swivel

Type	Tube Size	A	B	C	Ø	Kg
C35G20	26.9	32	38	8	10	0.15
C35G25	33.7	32	42	8	10	0.20
C35G32	42.4	32	47	8	10	0.21
C35G40	48.3	32	50	8	10	0.24
C35G50	60.3	48	60	8	10	0.47

The Male Swivel can be used on its own for use with a shackle and chain or with the C36 female swivel to mount rails at any angle for slopes. It can also be used for attaching flat sheets or boards to a structure and is available assembled with the C36 fittings as a C45 single swivel combination.

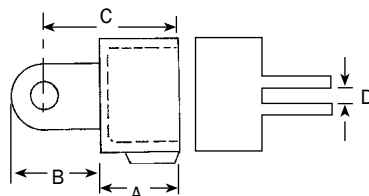
C36F Female Swivel

Type	Tube Size	A	B	C	D	Kg
C36G20F	26.9	39	35	53	10	0.24
C36G25F	33.7	41	35	60	10	0.33
C36G32F	42.4	44	35	63	10	0.38
C36G40F	48.3	50	35	70	10	0.46
C36G50F	60.3	70	40	95	10	0.84

The Female Swivel is designed as part of the swivel combination group of fittings. It can be used with the C10, C35, C37, C38 or C36M male swivel fittings.

C36M Male Swivel

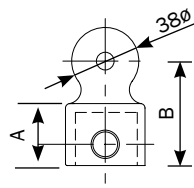

Type	Tube Size	A	B	Kg
C36G25M	33.7	30	60	0.28
C36G32M	42.4	40	70	0.40
C36G40M	48.3	45	75	0.44

The Male Swivel is designed as part of the swivel combination group of fittings. It can be used with C36F fittings.

C37 Double Male Swivel

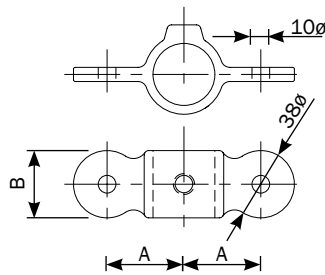

Type	Tube Size	A	B	Ø	Kg
C37G20	26.9	40	32	10	0.21
C37G25	33.7	44	32	10	0.28
C37G32	42.4	49	32	10	0.32
C37G40	48.3	52	32	10	0.46
C37G50	60.3	63	50	10	0.51

The Double Male Swivel is designed as part of the swivel combination group of fittings. It can be used with two C36 female swivel fittings. The double swivel combination is also available assembled as a type C47 fitting.

C38 90° Corner Male Swivel

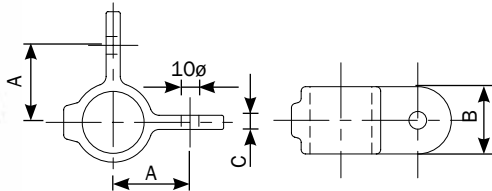

Type	Tube Size	A	B	C	Ø	Kg
C38G20	26.9	40	39	8	10	0.22
C38G25	33.7	44	38	8	10	0.34
C38G32	42.4	49	48	8	10	0.39
C38G40	48.3	53	48	8	10	0.47

The 90° Corner Male Swivel is designed as part of the swivel combination group of fittings. It can be used with two C36 female swivel fittings to make a corner combination fitting which is also available assembled as a type C48 type fitting.

C40 90° Crossover

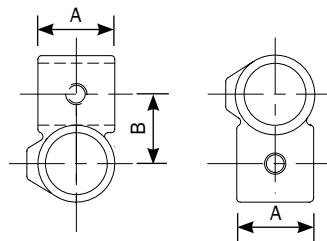

Type	Tube Size	A	B	Kg
C40G20	26.9	36	35	0.22
C40G25	33.7	40	40	0.34
C40G32	42.4	49	49	0.41
C40G40	48.3	55	55	0.57
C40G50	60.3	61	64	0.82
C40G25-32	33.7 / 42.4	45	45	0.46
C40G25-40	33.7 / 48.3	51	48	0.57
C40G32-40	42.2 / 48.3	51	52	0.59

The 90° Crossover connects two rails at 90° to each other and is often used for the handrailing when continuous standard lengths of tube are used. Please note that tube joints should use the C00 or C01 type fitting, and not the C40 type fitting.

C41 Clamp on Tee

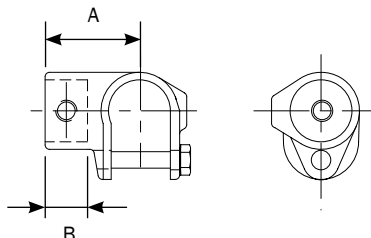

Type	Tube Size	A	B	Kg
C41G20	26.9	50	25	0.28
C41G25	33.7	53	25	0.45
C41G32	42.4	67	35	0.61
C41G40	48.3	77	35	0.79
C41G50	60.3	90	45	0.97

The Clamp on Tee is designed to allow a new tube to be joined to an existing structure. **Torque maximum 15N.M.** This uses a M10 stainless steel bolt.

C041 Level to Sloping Down Tee (30° to 45°)

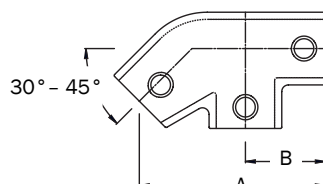

Type	Tube Size	A	B	Kg
C041G32	42.4	142	60	1.02
C041G40	48.3	154	68	1.12

Used to form a Tee on handrails where the rail changes from level to sloping down the stairs. Adjustable between 30° & 45°.

C42 Clamp on Crossover

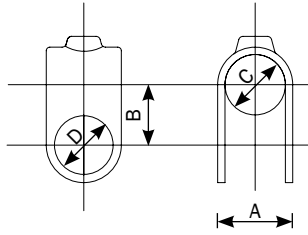

Type	Tube Size	A	B	C	D	Kg
C42G20	26.9	37	28	27	27	0.15
C42G25	33.7	44	34	34	34	0.27
C42G32	42.4	53	43	43	43	0.47
C42G40	48.3	58	49	49	49	0.54
C42G50	60.3	70	62	61	61	0.74

The Clamp on Crossover is designed to allow a new tube to be joined to an existing structure.

C042 Level to Sloping Up Tee (30° to 45°)

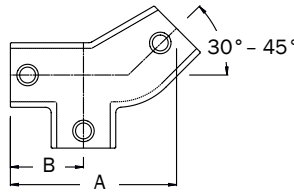

Type	Tube Size	A	B	Kg
C042G32	42.4	142	60	1.02
C042G40	48.3	154	68	1.12

Used to form a Tee on handrails where the rail changes from level to sloping up the stairs. Adjustable between 30° & 45°

C43 Combination Socket

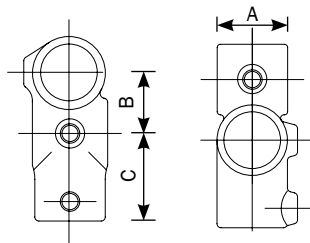

Type	Tube Size	A	B	C	Kg
C43G20	26.9	31	35	40	0.28
C43G25	33.7	42	40	48	0.49
C43G32	42.4	54	50	60	0.75
C43G40	48.3	60	56	67	0.90
C43G50	60.3	72	68	86	1.72

The Combination Socket is designed for racking and similar systems to allow a crossover to be combined with a cross tie.

C45 Single Swivel Combination

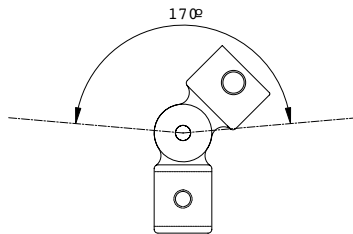

Type	Tube Size	Kg
C45G20	26.9	0.42
C45G25	33.7	0.55
C45G32	42.4	0.62
C45G40	48.3	0.73
C45G50	60.3	1.34

The Single Swivel Combination is designed to provide an angled tee between two tubes. It can be used to construct sloping handrail and for providing bracing struts to structures.

C46 Base Swivel Combination

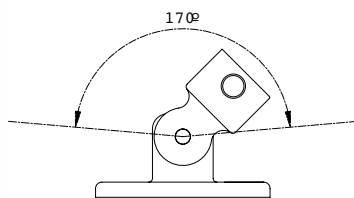

Type	Tube Size	Kg
C46G20	26.9	0.62
C46G25	33.7	0.87
C46G32	42.4	0.81
C46G40	48.3	0.85
C46G50	60.3	0.96

The Base Swivel Combination is designed to provide an angled wall or floor mounting. This fitting should not be used as a railing base without suitable support.

C47 Double Swivel Combination

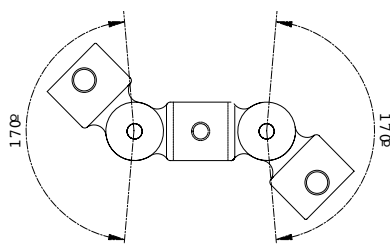

Type	Tube Size	Kg
C47G20	26.9	0.78
C47G25	33.7	0.99
C47G32	42.4	0.81
C47G40	48.3	1.32
C47G50	60.3	2.50

The Double Swivel Combination is designed to provide an in line angled joint as a post, this is suitable for the mid rail of a sloping handrail or to provide bracing to a structure.

C48 90° Corner Swivel Combination

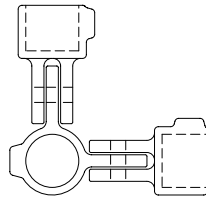

Type	Tube Size	Kg
C48G20	26.9	0.75
C48G25	33.7	1.00
C48G32	42.4	1.12
C48G40	48.3	1.46

The 90° Corner Swivel Combination is designed to provide an angled joint at a post, this is suitable for the mid rail of sloping handrail or to provide bracing to a structure.

C50 Slope Elbow (0° to 11°)

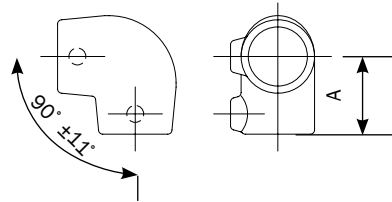

Type	Tube Size	A	Kg
C50G32	42.4	60	0.81
C50G40	48.3	67	1.02

The Slope Elbow is designed to provide an elbow for use on ramps. The variable angle allows the fitting to accommodate slopes up to 11°.

C51 Short Slope Tee (0° to 11°)

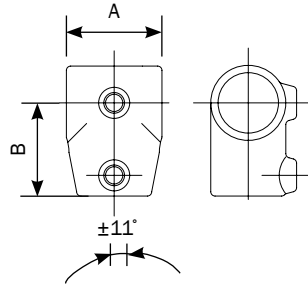

Type	Tube Size	A	B	Kg
C51G32	42.4	68	60	0.57
C51G40	48.3	72	68	0.76

The Slope Short Tee is designed to provide a T joint between two tubes for use on ramps. The variable angle allows the fitting to accommodate slopes up to 11°.

C52 Long Slope Tee (0° to 11°)

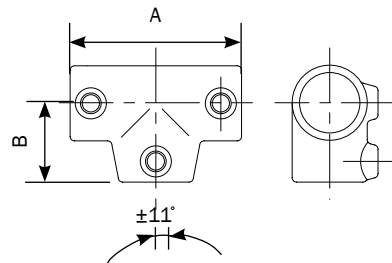

Type	Tube Size	A	B	Kg
C52G32	42.2	144	60	1.06
C52G40	48.3	158	67	1.10

The Slope Long Tee is designed to provide a T joint between two tubes for use on ramps. The variable angle allows the fitting to accommodate slopes up to 11°.

C53 Slope Base (0° to 11°)

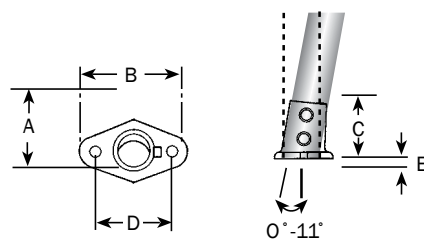

Type	Tube Size	A	B	C	D	E	∅	Kg
C53G32	42.2	91	140	79	102	10	14	0.90
C53G40	48.3	96	152	80	114	10	14	1.40

The Slope Base is designed to provide a base for use on ramps. The variable angle allows the fitting to accommodate slopes up to 11°.

C54 Slope 2 Socket Cross (0° to 11°)

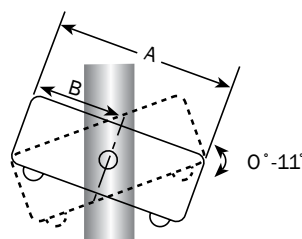

Type	Tube Size	A	B	Kg
C54G32	42.4	144	72	0.97
C54G40	48.3	158	79	1.00

The Slope 2 Socket Cross is designed to provide a joint for the midrail for use on ramps. The variable angle allows the fitting to accommodate slopes up to 11°.

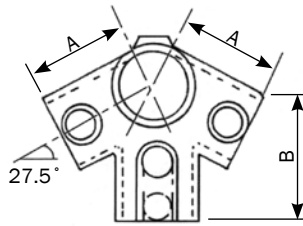
C55 27½° Ridge Fitting

Type	Tube Size	A	B	Kg
C55G40	48.3	67	89	1.00

A four way socket fitting used to construct the ridge of a roof structure.

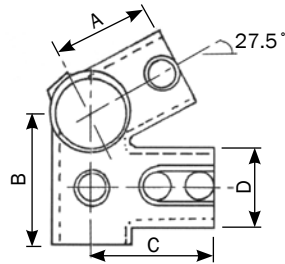
C56 27½° Eaves Fitting

Type	Tube Size	A	B	C	D	Kg
C56G40	48.3	67	89	83	51	1.16

A four way socket fitting used to construct the eaves of a roof structure.

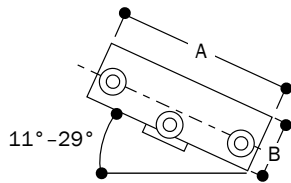
C57 Three Socket Tee (11° to 30°)

Type	Tube Size	A	B	Kg
C57G32	42.4	180	35	1.16
C57G40	48.3	216	40	1.46

Similar to a type C27, it is used on Safety Railing with slopes between 11°-30° and fixes the top rail to a vertical intermediate upright. Unlike the type C27 these components are ex-stock and do not require machining.

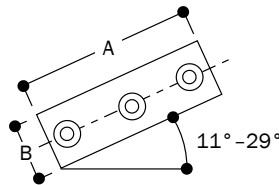
C58 Two Socket Cross (11° to 30°)

Type	Tube Size	A	B	Kg
C58G32	42.4	180	55	0.97
C58G40	48.3	216	60	1.26

Similar to a type C26, it is used on Safety Railing with slopes between 11°-30° and fixes the mid rail to a vertical intermediate upright. Unlike the type C26 these components are ex stock and do not require machining.

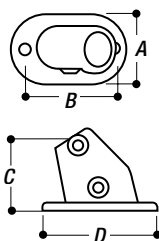
C59 Two Socket Cross (11° to 30°)

Type	Tube Size	A	B	C	D	Ø	Kg
C59G32	42.4	76	114	85	146	14	1.27
C59G40	48.3	89	124	95	164	14	1.42

Similar to a type C53, it is used to set the upright at an angle between 11°-30°. This fitting should only be subjected to light loads which cannot be positioned at 90° to the applied load. For greater loads or other tube sizes a type C12 flange should be used with the upright bent to the required angle Ø indicates the diameter of the fixing hole.

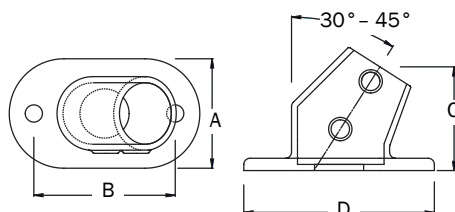
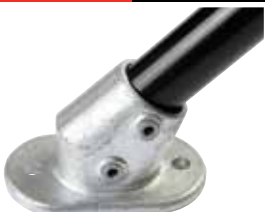
C59A Angle Base Flange (30° to 45°)

Type	Tube Size	A	B	C	D	Kg
C59AG32	42.4	76	106	81	138	1.17
C59AG40	48.3	89	115	85	155	1.53

Similar to a type C59, it is used to set the upright at an angle between 30° & 45°. This fitting should only be subjected to light loads which cannot be positioned at 90° to the applied load. For greater load use a type C12

C60 Spare Screws



Type	Tube Size
------	-----------

C60S25	26.9, 33.7 & 42.4
--------	-------------------

C60S32/40	48.3 & 60.3
-----------	-------------

Spare Screws come in two sizes, 1/4" ISO 228 for the 20 and 25nb range and 3/8" ISO 228 for the 32, 40 and 50 ranges.

C61 Allen Keys



Type	Tube Size
------	-----------

C61S25	26.9, 33.7 & 42.4
--------	-------------------

C61S32/40	48.3 & 60.3
-----------	-------------

Allen keys are available in two sizes, the first is suitable for the 20 and 25nb fitting and the other for the 32, 40 and 50nb fittings.

C62R Ratchet Keys



Type	Tube Size
------	-----------

C62R	ALL SIZES
------	-----------

The Ratchet driver and dual keys are available to speed assembly. The Ratchet driver will allow tightening to the correct torque.

C65P Plastic End Cap



Type	Tube Size	Kg
------	-----------	----

C65P20	26.9	0.008
--------	------	-------

C65P25	33.7	0.010
--------	------	-------

C65P32	42.4	0.010
--------	------	-------

C65P40	48.3	0.016
--------	------	-------

C65P50	60.3	0.024
--------	------	-------

Plastic End Caps are available for finishing plain end tubes. Available in grey plastic they will fit medium and heavy gauge tube.

C65G Metal End Cap



Type	Tube Size	Kg
------	-----------	----

C65G20	26.9	0.05
--------	------	------

C65G25	33.7	0.10
--------	------	------

C65G32	42.4	0.12
--------	------	------

C65G40	48.3	0.17
--------	------	------

C65G50	60.3	0.29
--------	------	------

This metal plug is hard to remove once it has been driven in. Note this metal insert can only be used in conjunction with tube with a wall thickness of 3.2mm. There is an alternative plastic version - C65P.

C66 Single Mesh Clip

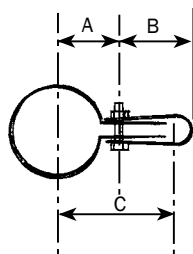

Type	Tube Size	A	B	C	Kg
------	-----------	---	---	---	----

C66G20	26.9	27	26	58	0.06
--------	------	----	----	----	------

C66G25	33.7	30	26	61	0.07
--------	------	----	----	----	------

C66G32	42.4	33	26	64	0.08
--------	------	----	----	----	------

C66G40	48.3	38	26	68	0.09
--------	------	----	----	----	------

C66G50	60.3	44	26	75	0.09
--------	------	----	----	----	------

The Single Mesh Clip is designed to provide a fixing for standard mesh panels. It is recommended that the clips are spaced at a maximum of 450mm apart.

C67 Double Mesh Clip

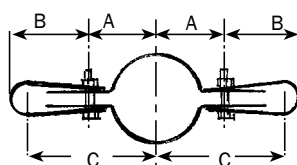

Type	Tube Size	A	B	C	Kg
------	-----------	---	---	---	----

C67G20	26.9	27	26	58	0.09
--------	------	----	----	----	------

C67G25	33.7	30	26	61	0.12
--------	------	----	----	----	------

C67G32	42.4	33	26	64	0.13
--------	------	----	----	----	------

C67G40	48.3	38	26	68	0.13
--------	------	----	----	----	------

C67G50	60.3	44	26	75	0.14
--------	------	----	----	----	------

The Double Mesh Clip is designed to provide a fixing for standard mesh panels. It is recommended that the clips are spaced at a maximum of 450mm apart.

C68 Weather Cowl

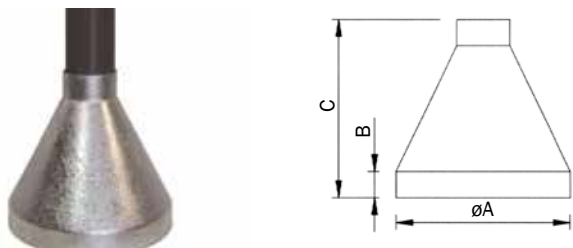

Type	Tube Size	A	B	H	Kg
C68G25	33.7	140	25	125	0.28
C68G32	42.4	150	25	150	0.33
C68G40	48.3	166	25	150	0.38

The Weather Cowl is designed to cover the Railing base and provides a weather proof seal when used with a suitable flexible sealant.

C69 Square Plastic End Cap

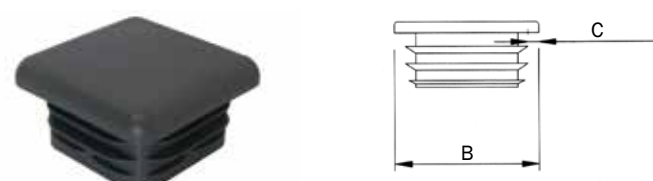

Type	Tube Size	B	C	Kg
C69P40X40	40x40SHS	40	3.2	0.01
C69P50X50	50x50SHS	50	3.2	0.01
C69P70X70	70x70SHS	70	3.2	0.02

The Plastic End Caps are available for finishing plain end square tubes. Available in grey plastic they will fit medium and heavy tube gauges.

C70 Crimp Straight



Type	Tube Size	AØ	B	Kg
C70G25	33.7	26.0	34.0	0.30

Straight Crimp Joints provide a permanent in-line connection for 33.7mm diameter x 3.2mm thick tube, a crimping tool is necessary.

C71 Crimp Elbow



Type	Tube Size	A	B	C	Kg
C71G25	33.7	26.0	38.0	34.0	0.47

Crimp Elbow provides a permanent 90° connection for 33.7mm diameter x 3.2mm thick tube, a crimping tool is necessary.

C72 Acute Angle Elbow (30° to 45°)



Type	Tube Size	A	Kg
C72G32	42.4	59	0.98
C72G40	48.3	68	1.45

Used when a junction between a sloping tube and an end post is required i.e guardrail on staircases between 30° & 45°

C72A Acute Angle Elbow (11° to 30°)



Type	Tube Size	A	Kg
C72AG32	42.4	58	0.94
C72AG40	48.3	63	1.12

The C72A is used as an alternative to bending, or when a junction between a sloping tube and an end post is required i.e. guardrail on staircases between 11° & 30°

C201LH Left hand Level to Sloping Down Side Outlet Elbow (30° to 45°)

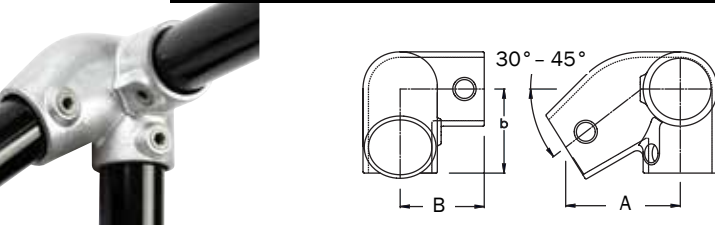

Type	Tube Size	A	B	Kg
C201LHG32	42.4	86	60	1.08
C201LHG40	48.3	93	68	1.28

Used to form a Left Hand Side Outlet Elbow on handrails where the top rail changes from level to sloping down the stairs. Adjustable between 30° & 45°

C201RH Right hand Level to Sloping Down Side Outlet Elbow (30° to 45°)

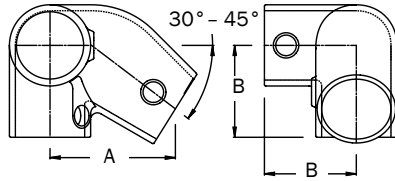

Type	Tube Size	A	B	Kg
C201RHG32	42.4	86	60	1.08
C201RHG40	48.3	93	68	1.28

Used to form a Right Hand Side Outlet Elbow on handrails where the top rail changes from level to sloping down the stairs. Adjustable between 30° & 45°

C211LH Left hand Level to Sloping Down Side Outlet Tee (30° to 45°)

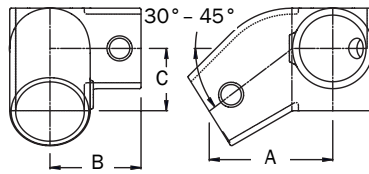

Type	Tube Size	A	B	C	Kg
C211LHG32	42.4	86	60	42	0.96
C211LHG40	48.3	92	68	47	1.12

Used to form a Left Hand Side Outlet Tee on hand-rails where the mid rail changes from level to sloping down the stairs. Adjustable between 30° & 45°

C211RH Right hand Level to Sloping Down Side Outlet Tee (30° to 45°)

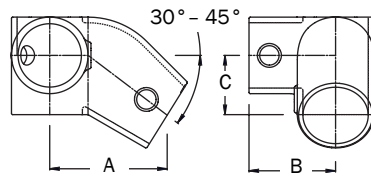

Type	Tube Size	A	B	C	Kg
C211RHG32	42.4	86	60	42	0.96
C211RHG40	48.3	92	68	47	1.12

Used to form a Right hand Side Outlet Tee on hand-rails where the mid rail changes from level to sloping down the stairs. Adjustable between 30° & 45°

C221 Level to Sloping Down / Up Cross (30° to 45°)

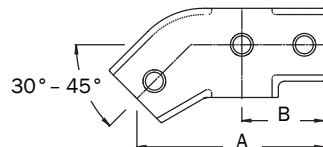

Type	Tube Size	A	B	Kg
C221G32	42.4	142	60	0.82
C221G40	48.3	154	68	0.95

Used to form a cross on handrails where the mid rail changes from either level to sloping down or level to sloping up the stairs. Adjustable between 30° & 45°.

C229 Single Socket Tee (11° to 30°)

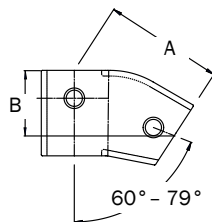

Type	Tube Size	A	B	Kg
C229G32	42.4	99	54	0.73
C229G40	48.3	109	59	0.86

The adjustable Short Tee fitting will accommodate any rake angle from 11° to 30°. It can be used for any Tee Joint to make an angle of between 11° & 30°.

C245 Three Socket Tee (30° to 45°)

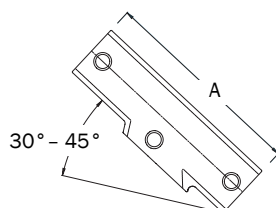

Type	Tube Size	A	Kg
C245G32	42.4	180	0.95
C245G40	48.3	216	1.22

This fitting is used on Safety Railing with slopes between 30° & 45° and fixes the top rail to a vertical intermediate upright

Handrailing for the disabled

Under the terms of the Equality Act 2010 (previously the Disability Discrimination Act), reasonable adjustments need to be made to public and commercial buildings to overcome physical barriers which prevent disabled access. The Building Regulations recommend an outside diameter tube size for installations of between 40mm-45mm.

Our DDA range has been designed to meet these requirements by providing a non-discriminatory handrail solution that complies with the Equality Act and Part 'M' of the Building Regulations. The range allows construction of a smooth continuous handrail of 42.4mm diameter.

DDA fittings are supplied Hot dip Galvanised as standard but can be supplied in a powder coated finish to RAL standard colours (subject to quantity and availability from the coaters). In cold temperatures a powder coated finish will give the impression of being warmer to the touch.

The DDA Range

Designed to satisfy the requirements of Part 'M' of the Building Regulations 2004



DDA01 Upright Connector

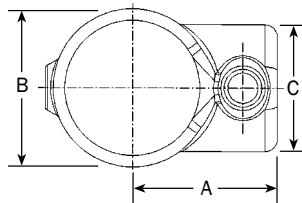

Type	A	B	C	Kg
DDA01	55	60	50	0.38

Connector for attaching the DDA04 intermediate bracket or the DDA02 handrail connector to the 48.3mm o/d upright.

DDA02 Handrail Connector

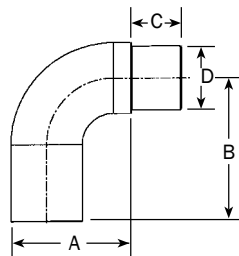

Type	A	B	C	D	Kg
DDA02	51	86	30	38	0.48

Connector (made from Ductile Iron) for attaching the end of the 42.4mm o/d handrail tube at 90° to the 48.3mm o/d upright. This bracket is used in conjunction with DDA01 and DDA07.

DDA03 Wall Bracket

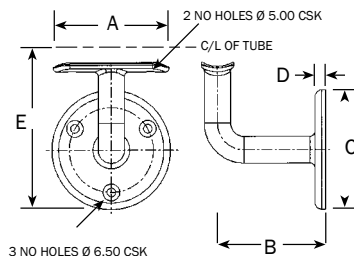

Type	A	B	C	D	E	Kg
DDA03	88	82	90	8	84	0.62

Bracket (made from Ductile Iron) for supporting the 42.4mm o/d handrail tube to a wall. The 42.4mm o/d tube is fixed to the DDA03 using either 2 x self tapping screws or 2 x pop rivets.

DDA04 Intermediate Bracket

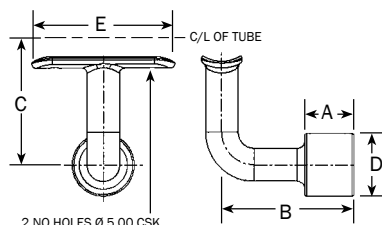

Type	A	B	C	D	E	Kg
DDA04	30	81	84	38	88	0.44

Bracket (made from Ductile Iron) for supporting the top or middle rail tube at an upright in conjunction with a DDA01. The 42.4mm o/d tube is fixed to the DDA04 using either 2 x self tapping screws or 2 x pop rivets.

The DDA Range

DDA05 End Return

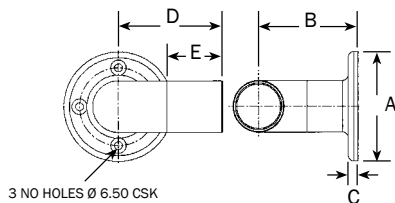

Type	A	B	C	D	E	Kg
DDA05	90	82	8	86	46	0.64

Bracket (made from Ductile Iron) for terminating the 42.4mm o/d handrail tube back to a wall. This bracket is used in conjunction with a DDA07.

DDA06 90° Bend

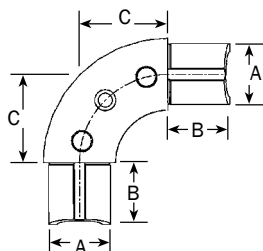

Type	A	B	C	Kg
DDA06	33.7	35	50	0.93

Expanding elbow (made from Ductile Iron) for creating a smooth 90° bend in the 42.4mm o/d tube.

DDA07 Expanding Connector

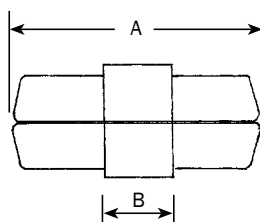

WARNING! Inline internal connector for joining two tubes together. Only medium gauge 3.2mm wall thick tube can be used. The DDA07 should never be used as a load bearing joint. The DDA07 must be used within 100mm of an upright.

Type	A	B	C	Kg
DDA07	42.4	75	19	0.35

Expanding internal connector for joining sections of 42.4mm o/d tube, or other DDA fittings as and when required.

DDA08 Plastic End Cap

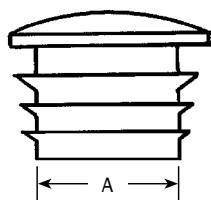

Type	A	Kg
DDA08	48.3	0.016

48.3mm o/d plastic end cap for inserting into the open tube on the top of the upright. For a permanent fix, a suitable adhesive should be used.

DDA09 Adjustable Bend

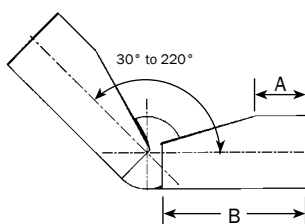

Type	A	B	Kg
DDA09	31	86	0.61

Fitting (made from Ductile Iron) for creating an adjustable bend between the horizontal and the vertical.



Defender Roof Edge Protection systems operate on a counterbalance principle using curved PVC counterweights as the main component. A galvanised malleable iron foot with a protective rubber base supports the handrail post; this includes an integral toeplate facility which is a fundamental requirement if there is no perimeter edge upstand.

All systems feature 1100 mm tall factory preassembled uprights that include open cradle fittings allowing the handrail tube to be quickly dropped into place instead of the time consuming process of the tube being fed through several fittings as required with other systems, speeding up assembly and saving cost.

For more information on **Defender Roof Edge Protection** please contact our Sales Office on **01384 632385**.

Benefits of Defender Roof Edge Protection

- System is effectively maintenance free with hot dip galvanised fittings and tube to BS EN ISO 1461
- Recycled PVC counterweights
- For use on asphalt, coated steel sheeted, concrete or mineral felt roofs
- Rapid installation, no special tools or specialised labour required
- No on site welding or bending required
- Base fitting allows option of installing uprights up to 11° from vertical
- Bolt on toeplate available to comply with HSG 33.

FastClamp fittings are used in construction of Defender **Roof Edge Protection** systems. Our systems are freestanding, with no requirement for fixings or drilling and subsequently no repair to the roof membrane, suitable for flat roofs up to 3° pitch.

The systems can be configured to satisfy the requirements of BS EN 13374 Class A.



ECONOMY SYSTEM
A simple and cost effective way of protecting roof edges.



STANDARD SYSTEM
Shorter length counterweight tubes, enables installation in restricted roof areas.



PLUS SYSTEM
Aesthetically pleasing, curved uprights with 3 rails for added security.



SELF-CLOSING SAFETY GATES

FastClamp® supplies a range of self-closing industrial safety gates. Our gates are suitable for external and internal applications, and can be retro-fitted to existing structures.

The gates are spring loaded to automatically close behind the user, to provide a safe environment and overcome the problem of human error. **FastClamp**® industrial safety gates provide a safe access to demarcated areas within factories, warehouses and loading bays.

FastClamp® industrial safety gates are compliant with the requirements of EN 13374 and EN 14122. The gates have been extensively tested to ensure their durability and reliability.

FastClamp® self-closing safety gates are supplied 1m wide and 2 x 0.9m wide for larger openings. The gates are available either hot dipped galvanised or powder coated in safety yellow and can be easily trimmed to size on-site.

- Single and double width gates
- Easy to assemble
- Performance tested for trouble free operation
- Fully adjustable for varying widths

How to calculate correct tube cutting length using types C05A, C57, C58, C59A, C72A & C229 on slopes between 11° to 30°

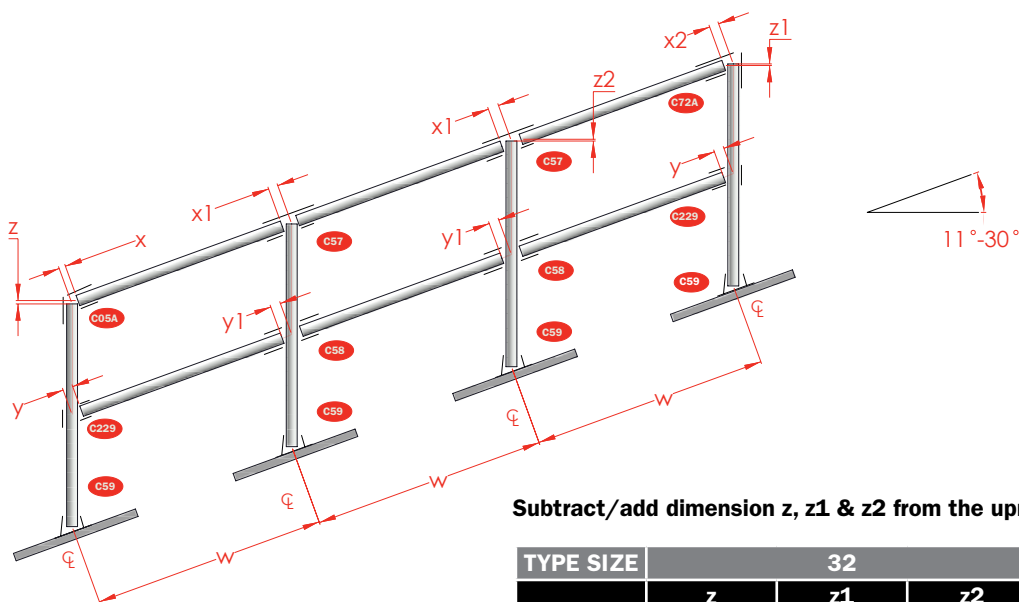

Subtract/add dimension z, z1 & z2 from the upright height

TYPE SIZE	32			40		
	z	z1	z2	z	z1	z2
11°	-10	-28	+7	-20	-34	+6
15°	-11	-25	+7	-25	-29	+6
20°	-13	-34	+7	-21	-39	+6
25°	-15	-43	+7	-22	-50	+6
30°	-18	-53	+7	-4	-61	+6

x Dimensions to be added/subtracted from upright height

Subtract dimension x, x1, x2, y or y1 from upright centres (w). Please note the upright centres must be measured on the slope

TYPE SIZE	32					40				
	x	x1	x2	y	y1	x	x1	x2	y	y1
11°	-25	-26	-35	-52	-26	-26	-29	-35	-51	-29
15°	-21	-28	-46	-53	-58	-22	-31	-47	-52	-31
20°	-16	-30	-48	-55	-30	-20	-34	-50	-54	-34
25°	-15	-33	-52	-59	-33	-14	-38	-54	-57	-38
30°	-8	-37	-57	-64	-42	-29	-42	-60	-62	-42

How to calculate correct tube cutting length using types C041, C042, C12 & C221 on slopes between 30° to 45°

Subtract dimension x to determine rail size on level

TYPE SIZE	32	40
	x	x
35-45°	-21	-24

y Dimensions to be subtracted from upright centres

Please note upright centres must be measured on the slope

TYPE SIZE	32	40
	y	y
30°	-47	-57
35°	-52	-62
40°	-59	-69
35°	-68	-79

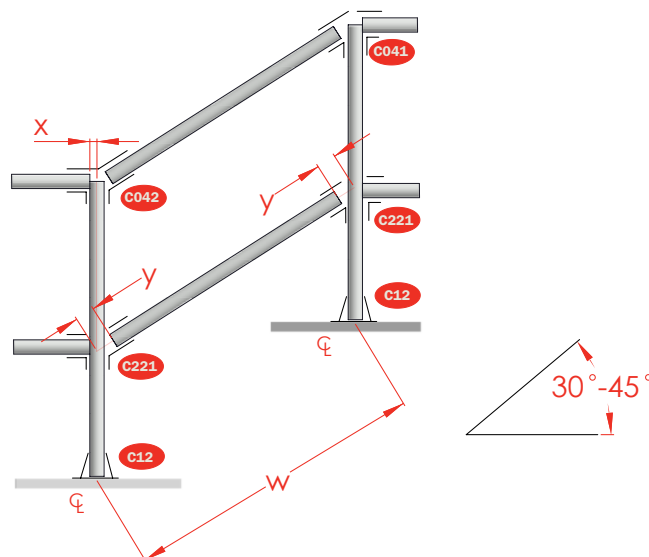

How to calculate correct tube cutting length using types C05, C245, C28, C59A, C72 & C29 on slopes between 30° to 45°

Subtract/add dimension z, z1 & z2 from the upright height

TYPE SIZE	32			40		
	z	z1	z2	z	z1	z2
30°	-17	-48	+5	-27	-47	+6
35°	-16	-59	+5	-21	-53	+6
40°	-8	-69	+5	-14	-68	+6
55°	-2	-80	+5	-5	-79	-4

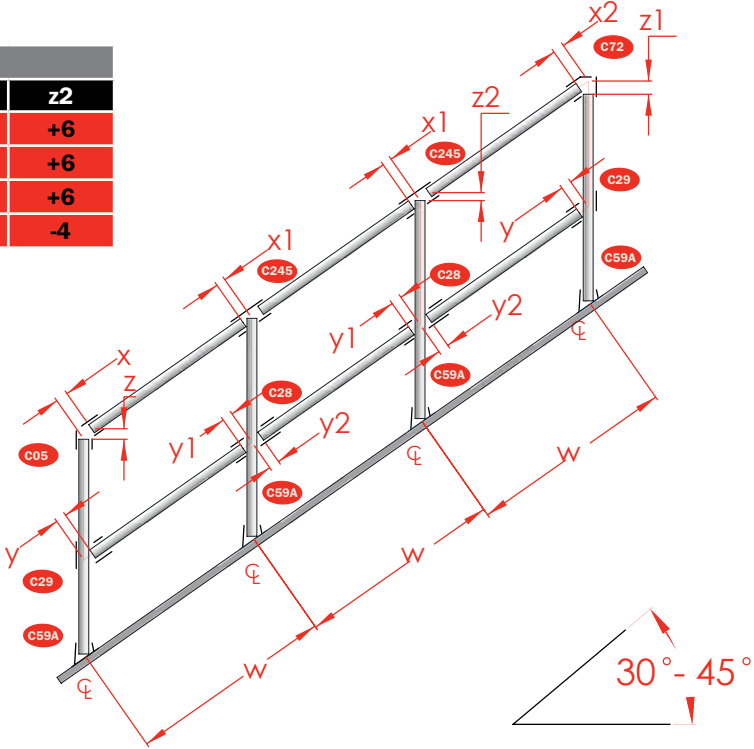

Subtract dimension x, x1, x2, y or y1 from upright centres (w). Please note the upright centres must be measured on the slope

TYPE SIZE	32					40				
	x	x1	x2	y	y1	x	x1	x2	y	y1
30°	-20	-39	-55	-37	-49	-17	-42	-48	-43	-64
35°	-16	-44	-61	-40	-50	-18	-46	-60	-47	-64
40°	-20	-47	-71	-45	-51	-21	-52	-65	-52	-64
45°	-26	-50	-85	-51	-51	-26	-58	-60	-59	-64

How to calculate correct tube cutting length for straight and level handrails

w = Distance between uprights \varnothing to \varnothing

TYPE	SIZE
32	40
x	x
-22	-25

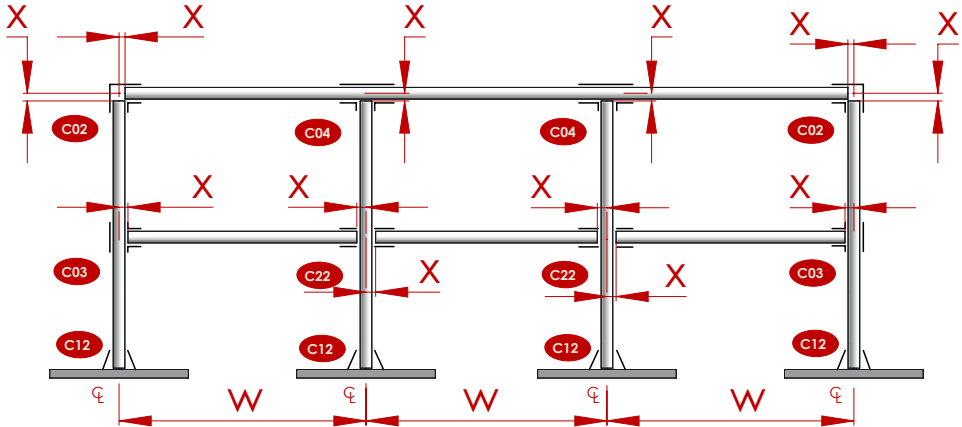



Access Technologies Limited

Cradley Business Park
Overend Road
Cradley Heath
West Midlands, B64 7DW

Tel 01384 632385
Fax 01384 632384
email sales@fastclamp.com

www.fastclamp.com

©Access Technologies Limited 2017. No part of this brochure may be reproduced without the written permission of Access Technologies Limited. All Rights Reserved.

FC24pp_V1_01/17